

CARACTERÍSTICAS / FEATURES

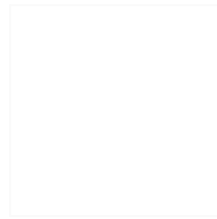

Material hormigón Petra 1 + madera
Acabado decapado e hidrofugado
Dimensiones l. 180, a. 62,50, h. 80 cm
Color ver carta de colores
Fijación apoyado por su propio peso o mediante varillas metálicas
Peso 116 Kg
Palet 200 x 80 cm (5 un)

Material precast concrete Petra 1 + wood
Finish sanded and waterproofed
Dimensions l. 180, w. 62,50, h. 80 cm
Colour see colour catalogue
Fixing resting on the ground or with metal rod
Weight 116 Kg
Pallet 200 x 80 cm (5 un)

diseñador / design: magourban

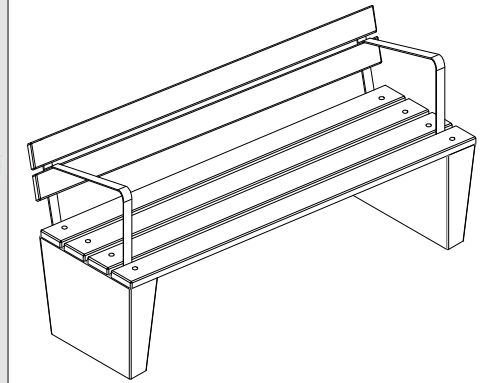

ARECA R

GEOMETRIA / GEOMETRY

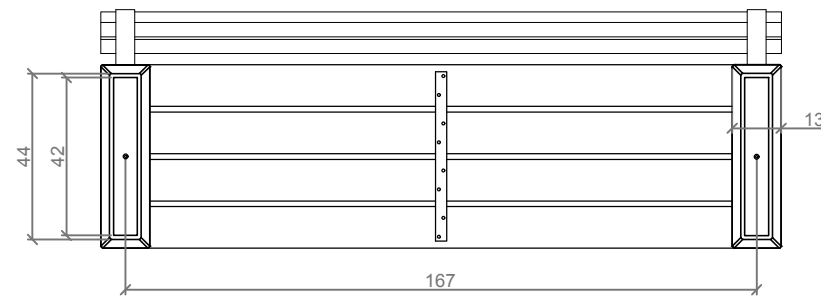

VISTA INFERIOR / BOTTOM VIEW

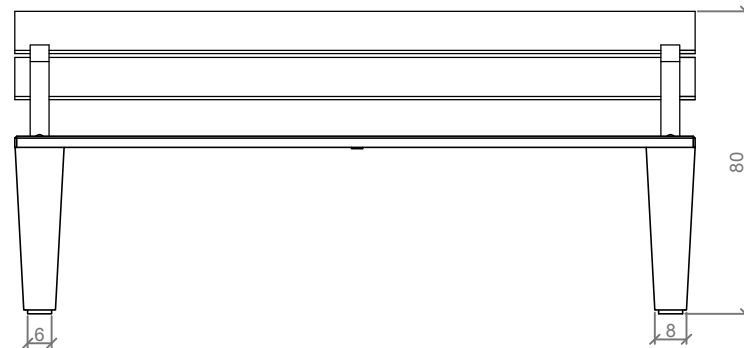

ALZADO / FRONT VIEW

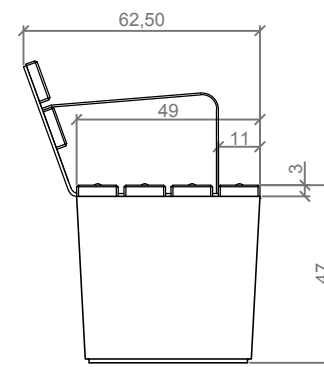

PERFIL / PROFILE

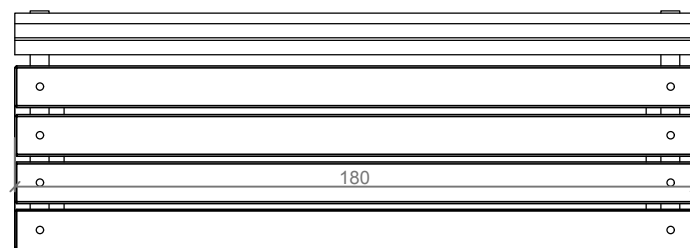

PLANTA / TOP VIEW

MANIPULACIÓN E INSTALACIÓN / HANDLING AND INSTALLATION

1 Enroscar la varilla
Thread the rod

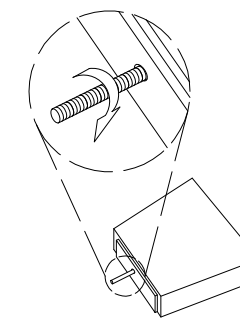

2 Perforar 2 agujeros a una distancia de 167 cm
Drill 2 holes each other at a distance of 167 cm

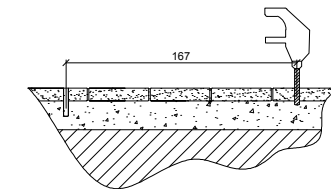

3 Verter resina epoxy / pour resin epoxy

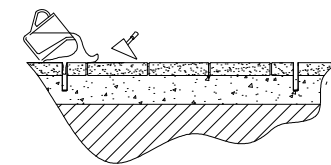

ATENCIÓN!!! DEBE INSTALAR LOS SOPORTES CON LA FLECHA ORIENTADA HACIA EL INTERIOR
ATTENTION !!! SHOULD INSTALL SUPPORTS WITH ARROW ORIENTED TO INSIDE

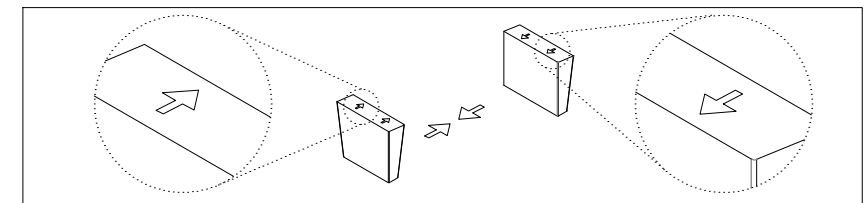

4 Insertar la varilla en el agujero
Insert metal rod in hole

5 Instalar soportes + madera y fijar tornillos
Install wood + support & tightening screw.

Elevación / Hoisting
P= 50 Kg

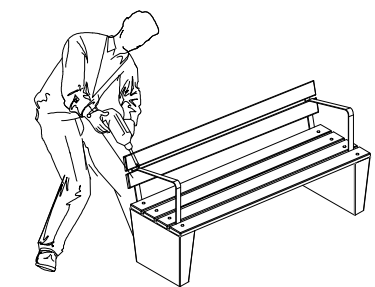
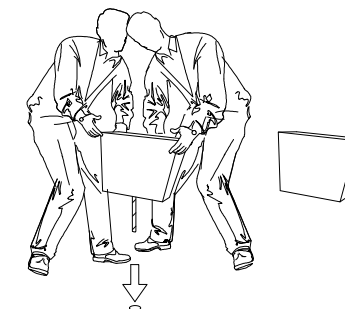

ESPECIFICACIONES / SPECIFICATIONS

DETALLE B / DETAIL B

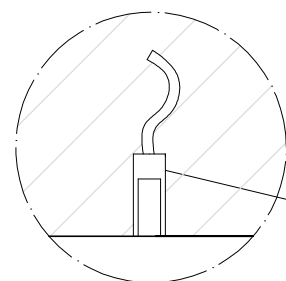

Casquillo M12 - Tubo acero zincado alta precisión
Tube M12 - Galvanized steel pipe high precision

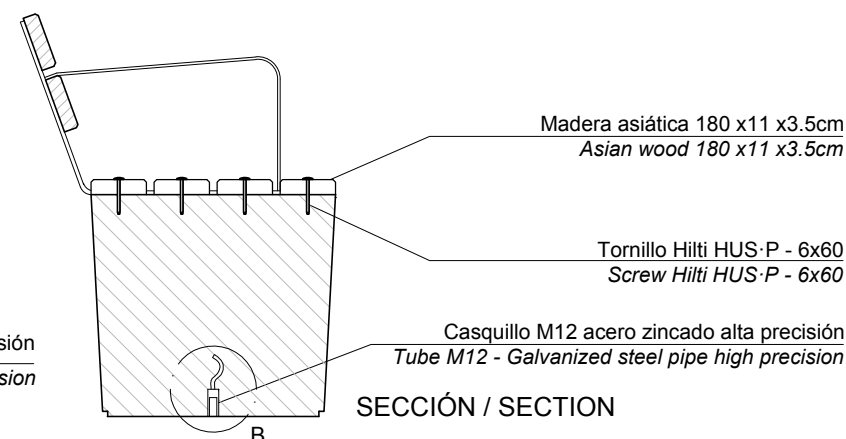

Madera asiática 180 x11 x3.5cm
Asian wood 180 x11 x3.5cm

Tornillo Hilti HUS-P - 6x60
Screw Hilti HUS-P - 6x60

Casquillo M12 acero zincado alta precisión
Tube M12 - Galvanized steel pipe high precision

SECCIÓN / SECTION