

CARACTERÍSTICAS / FEATURES

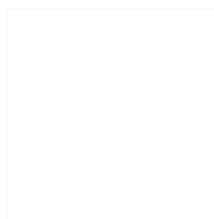

Material hormigón Petra 1
Acabado decapado e hidrofugado
Dimensiones l. 100, a. 60, h. 93 cm
Color ver carta de colores
Fijación apoyado por su propio peso o mediante resina epoxi
Peso 340 Kg / 360 L
Palet 110 x 65 cm

Material precast concrete Petra 1
Finish scaled and waterproofed
Dimensions l. 100, w. 60, h. 93 cm
Colour see colour catalogue
Fixing resting on the ground or with epoxy resin
Weight 340 Kg / 360 L
Pallet 110 x 65 cm

diseñador / design: magourban

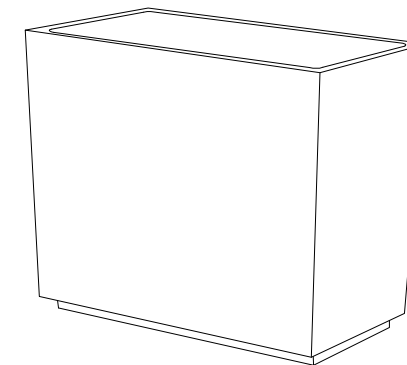

KONIQ JRA-100

GEOMETRIA / GEOMETRY

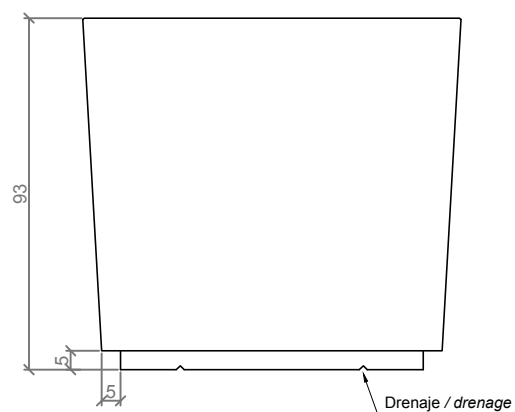

ALZADO / FRONT VIEW

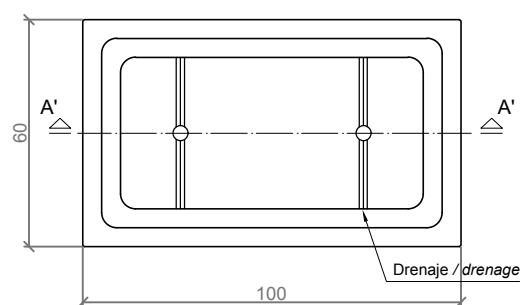

VISTA INFERIOR / BOTTOM VIEW

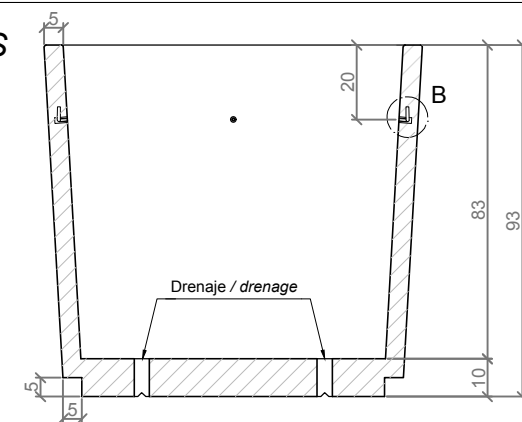

SECCIÓN A-A' / SECTION A-A'

Casquillo M12
 Tubo acero zincado alta precisión
 Tube M12
 Galvanized steel pipe high precision

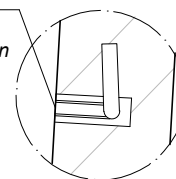

DETALLE B-B' / DETAIL B-B'

MANIPULACIÓN E INSTALACIÓN / HANDLING AND INSTALLATION

1 Elevar con eslingas e instalar / Raise with slings and install.

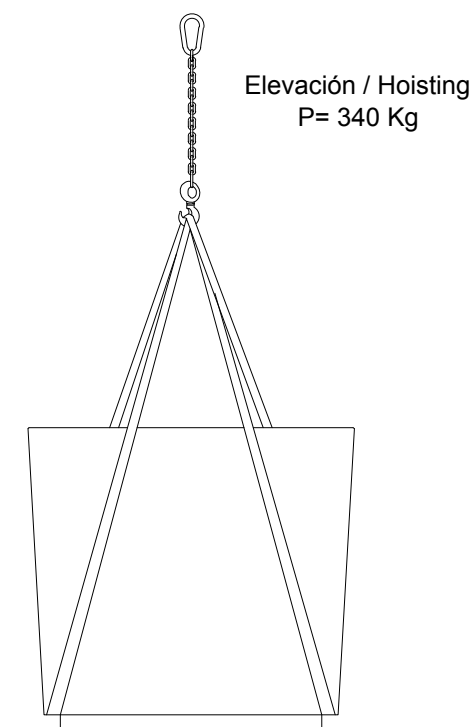

Elevación / Hoisting
 P= 340 Kg

ESPECIFICACIONES / SPECIFICATIONS

Tàrrega, Lleida - Tel. +34 973 15 87 03 - www.magourban.com - info@magourban.com

magourban

mm