

CARACTERÍSTICAS / FEATURES

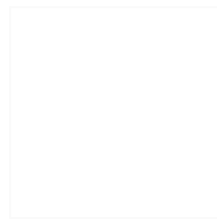

Material hormigón Petra 1
Acabado decapado e hidrofugado
Dimensiones l. 260, a. 50, h. 45 cm
Color ver carta de colores
Fijación apoyado por su propio peso o mediante resina epoxi
Peso 888 Kg
Palet 270 x 55 cm

Material precast concrete Petra 1
Finish scaled and waterproofed
Dimensions l. 260, w. 50, h. 45 cm
Colour see colour catalogue
Fixing resting on the ground or with epoxy resin
Weight 888 Kg
Pallet 270 x 55 cm

diseñador / design: magourban

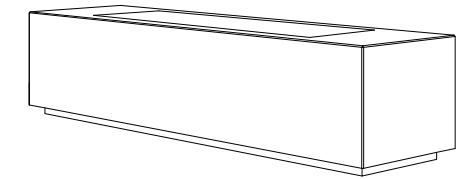

DYNAMIC I-260 TUC

GEOMETRIA / GEOMETRY

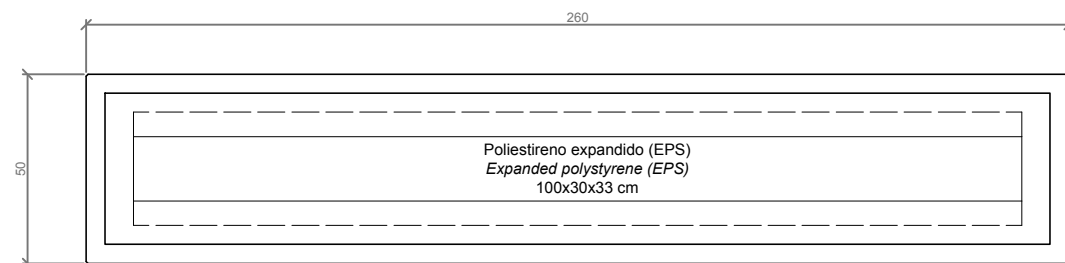

VISTA INFERIOR / BOTTOM VIEW

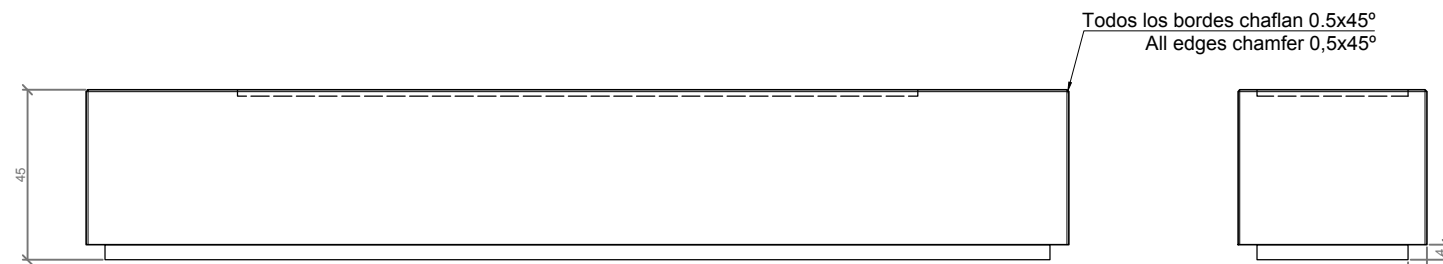

ALZADO / FRONT VIEW

PERFIL / PROFIL VIEW

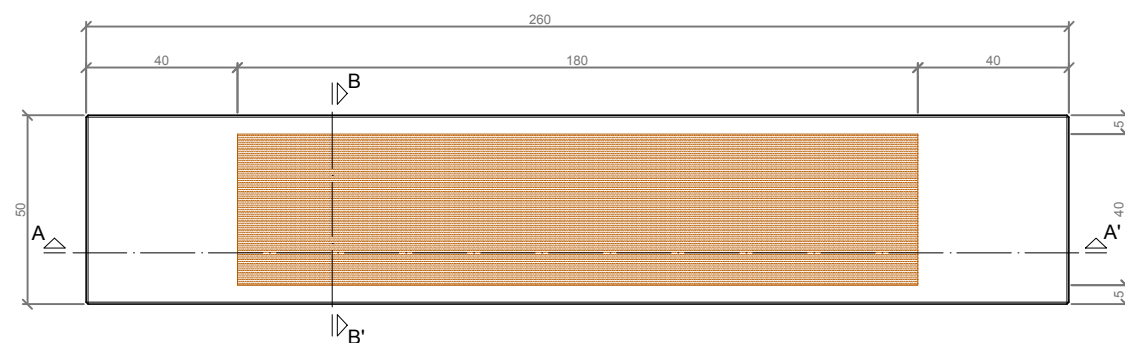

PLANTA / TOP VIEW

ESCALA / SCALE: 1 / 20

MANIPULACIÓN E INSTALACIÓN / HANDLING AND INSTALLATION

- 1 Elevar con eslingas e instalar
Raise with slings and install

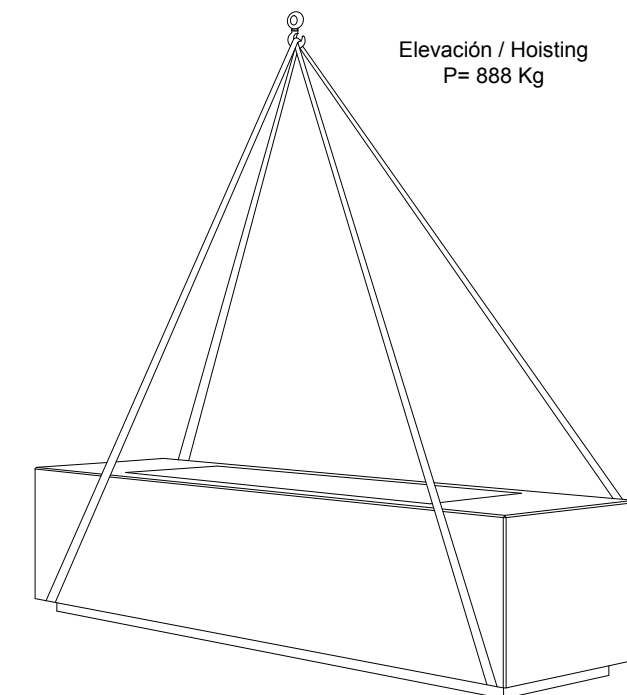

ESPECIFICACIONES / SPECIFICATIONS

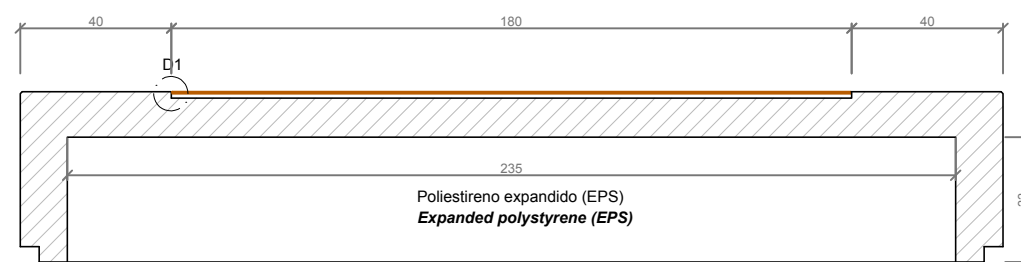

SECCIÓN A-A' / SECTION A-A'

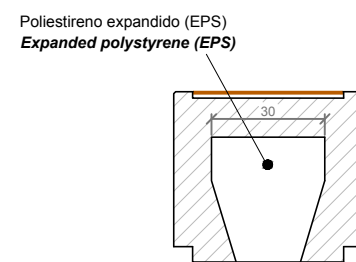

SECCIÓN B-B' / SECTION B-B'

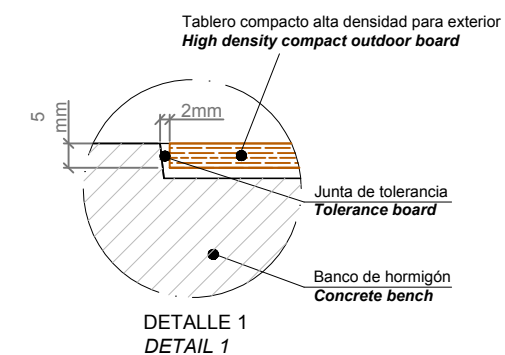

DETALLE 1
DETAIL 1